

Next generation Medical Simulator  
mikoto Colonoscopy Model  
R0CT01

User's Manual

R ZERO Inc.

Ver.2.3

# Contents

1. Introduction	2
2. Safety precautions	3
3. Before Use	6
4. Preparations	
4 – 1 Place the colonoscopy simulator on a level surface	8
4 – 2 Power supply connection	8
4 – 3 Connecting peripheral devices	8
4 – 4 How to use lubricants	8
4 – 5 Endoscope preparation	9
5. Operation	
5 – 1 Startup of the main unit	10
5 – 2 Start of training	11
5 – 3 Observation	14
5 – 4 Operator registration	14
5 – 5 Replay of training content	15
5 – 6 Issue of certificates	18
5 – 7 Settings	20
① Wi-Fi	20
② Language	21
③ Display option	22
④ Sound option	23
⑤ Sensor sensitivity	24
⑥ Register	24
⑦ Consent form	25
⑧ Data management	28
⑨ System log	28
⑩ License	29
⑪ User's manual	29
5 – 8 Update	30
6. Exit operation	
6 – 1 Power off	30
6 – 2 Installation of anal cover	30
7. Specification	31
8. Declaration of conformity	31
9. Optional parts (consumables)	34
Inquiries	35

## 1. Introduction

This product is an educational training simulator for colon insertion practice and observation practice at the time of removal. It reproduces the sensation of insertion close to that of a human being, enabling practice of procedures close to actual practice.

### ★ Please be sure to read the following.

Do not use the product for any purpose other than its intended use. Please note that we are not responsible for any damage or accident that may occur by using the product in a manner other than that described in the instruction manual.

### ★ Product Features

#### 【Ease to use】

- Quick set up
- Build-in touch panel display

#### 【Portable material and size】

- Lightweight (8.7 kg), box type, compact in size

#### 【Easy to maintain】

- Vegetable oil-based lubricant
- No need to clean-up after use

### ★ Product Function

#### 【Realistic colon model】

- Soft material, smooth surface
- Realistic fold shape and texture
- Multiple polyps

#### 【Self-learning can be achieved】

- Recording videos for personal review
- Procedure scoring system
- 4 adjustable difficulty settings



※Specifications of this product are subject to change without notice.



### ★Product Safety





The overall safety of this product system is the responsibility of the system assembler. Refer to this manual for actual handling instructions.













## 2. Safety precautions





To prevent injury to persons and damage to equipment, please follow the following instructions.









 <b>DANGER</b>	Extent of imminent hazard which has the potential to cause death or serious injury to the user in the case of improper handling.
 <b>WARNING</b>	Extent of hazard which has the potential to cause death or serious injury to the user in the case of improper handling.
 <b>CAUTION</b>	Extent of hazard or damage which has the potential to cause injury to the user or damage to physical property (houses and household goods) in the case of improper handling.

	This symbol means “prohibited” (never do this)		This symbol means “compulsory” (be sure to do)
--	---	--	---

 <b>DANGER</b>	
	Do not apply shock or pressure to this product. Failure to do so may result in malfunction or injury.
	Do not heat the product or place it in a fire. Doing so may cause overheating, fire, or electric shock.
	Do not use the product near fire or heat appliances. Doing so may cause overheating, fire, or electric shock.
	Do not use medical devices such as electrocautery or forceps other than endoscopes. Doing so may cause malfunction.





 <h1>WARNING</h1>	
	<p>Never attempt to disassemble, modify, or repair the product. Disassembly, modification, or repair may cause fire, malfunction, injury, or electric shock. For repair, please contact our regional representative or the distributor from which you purchased or R ZERO Inc. (E-mail:mikoto@rzero.jp)</p>
	<p>In case of abnormality or malfunction, stop using the product immediately and unplug it from the power supply. Immediately contact our inquiry desk.</p>
	<p>Endoscopes inserted into the unit may contain residual lubricant. Please reprocess the endoscope in accordance with the endoscope manufacturer's reprocessing manual.</p>
	<p>Do not disconnect the power plug during operations (e.g. while changing the difficulty level or moving the abdominal pressure plate or the power lamp is blinking when the unit is shutting down.)</p>
	<p>Do not move the product while energized. Transporting or carrying this product with the power on may cause electric shock, malfunction, or failure. Always turn off the power and disconnect the power plug before moving the product.</p>
	<p>Do not open the lid of the device while the power is on and do not put your hand inside. Doing so may cause injury.</p>
	<p>Do not apply excessive force to the colon modeling model or allow it to come into contact with sharp objects. Doing so may cause damage.</p>
	<p>If the colon model is torn or damaged, please stop the training and shut down the unit. Using the colon model in its original state may damage the endoscope coming out of the damaged area or cause the lubricant to leak into the unit, resulting in a malfunction. Please wipe up any leaked lubricant and tie up the damaged part or cover it with a plastic bag to prevent further leaking. After that, please contact the distributor which you purchased the unit.</p>
	<p>Do not put any liquid other than the dedicated lubricant oil into the colon model or get the unit wet. It may cause the malfunction, electric shock or fire.</p>
	<p>Do not inject the lubricant through a working channel of an endoscope. It may cause poor visibility of endoscopic video image.</p>
	<p>The Lubricant should only be used for the colon models.</p>

	Keep lubricant away from ignition sources such as heat, sparks, naked flames, and hot objects. Failure to do so may cause fire.
	When unplug a connector of a cable, do not pull the cable but always hold and pull the connector. If not, the connector or the cable may be damaged, resulting in electric shock or fire.
	Do not press metal objects into the contacts. Doing so may cause heat generation, fire, or electric shock.
	Make sure to insert the power plug all the way to the root. If the plug is not pushed in properly, it may cause ignition or electric shock.
	Use the accessory products that are bundled with the unit for connection to the unit. Do not use other products as they cannot be used or may cause malfunctions. Also, if the power cord needs to be replaced, contact the dealer from whom you purchased the product.

 <b>CAUTION</b>	
	Clean the unit with neutral detergent.
	Store the product away from direct sunlight, high temperature and high humidity. Doing so may cause deformation, discoloration, or malfunction.
	 Areas marked with this symbol are moving parts. Be careful not to get your hands or fingers caught. Doing so may cause injury or malfunction.
	Attach the supplied anal cover to the anal part of the colon model and keep it in place. Lubricant may leak from the inside of the colon model to the outside.
	The Wi-Fi function will only be in a state where the connection is permitted if the unit is the client. The Bluetooth function will also lock access to the part to be configured and the wireless function will be disabled.
	When transporting the unit, keep it in the packing box that was used when the unit was delivered or in a case that can mitigate external shocks. Do not drop the unit or subject it to impact. Doing so may result in damage to parts or malfunction.
	Use of the equipment in a manner not specified by the manufacturer when using the equipment will impair the protection provided by the equipment and should be used in accordance with the handling instructions in this manual.

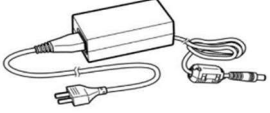
### 3. Before use

■ Product components (main unit and accessories)

<p>&lt;Main unit&gt;</p> 	<p>&lt;AC adapter&gt;</p> 	<p>&lt; Operator's camera &gt;</p> 
<p>&lt;USB Analog Video Capture&gt; ※</p>  <p>Including extension cable</p>	<p>&lt;Lubricant &gt;</p> 	

※ This accessory may not be included in some sales areas. For details, contact the dealer.

※ Although this product is manufactured and inspected with the greatest possible care, there may be minute scratches on the exterior during the manufacturing process . This does not affect the performance or function of the product. Please be aware of this beforehand.

■ Name of each part of the main unit

【Front side】

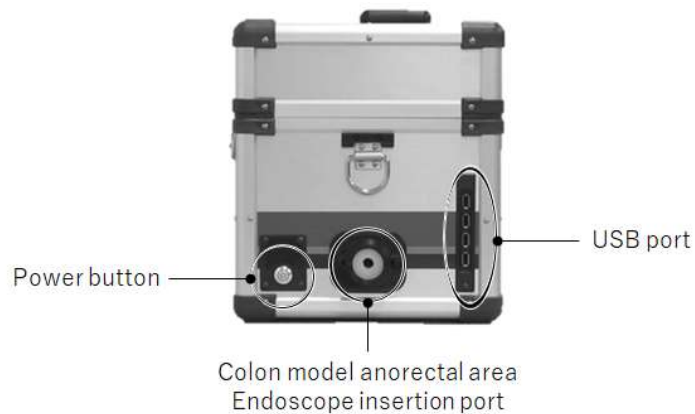

【Back side】

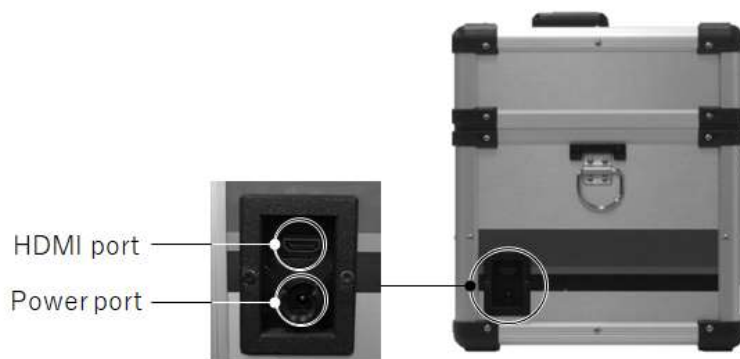

**【Inner upper panel】**

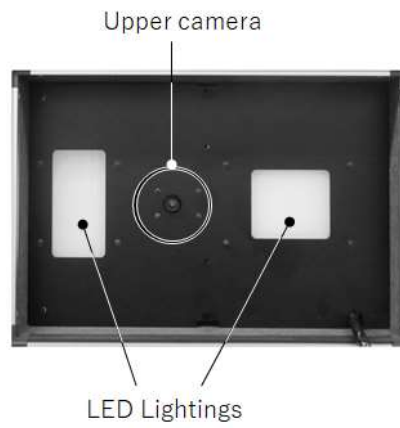

**【Internal】**

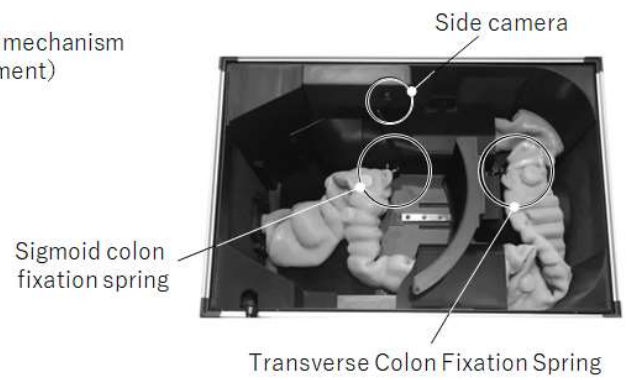
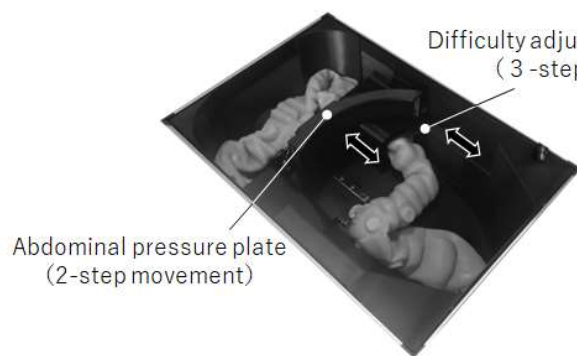

**【Mounting Parts】**





## 4. Preparations

### 4 – 1 Place the colonoscopy simulator on a level surface

Depending on the location, place a sheet or similar material underneath the simulator to prevent contamination by the lubricant.

### 4 – 2 Power supply connection

Plug the AC adapter into the power port of the main unit and the power plug into a wall outlet.

### 4 – 3 Connecting peripheral devices

- Plug the operator's camera and USB analog video capture into the USB port on the main unit.
- The connection to the endoscope system and a monitor are as shown in the figure below.
- A keyboard and a mouse can be connected for the operation.

< Overall connection diagram and connection type >



Endoscope video input: composite video signal.

(Composite or S video, some models may use SDI or BNC terminal for it.)

### 4 – 4 How to use lubricants

- Remove the anal cap.
- Inject the lubricant into the sponge while rotating the part, so that the lubricant is fully applied.



Remove the anal cap



Inject the lubricant while rotating the part



If too much oil is injected into the sponge, the lubricant may start leaking from the part. Please inject it a little at a time.

※The inside of the colon model is sufficiently filled with lubricant. If an endoscope does not glide well, please add the lubricant from the inlet shown below, attach the cap you removed and slowly shake the colon model to spread the oil inside.

When injecting the lubricant, hold the area around the inlet securely. If not, the lubricant may leak out.

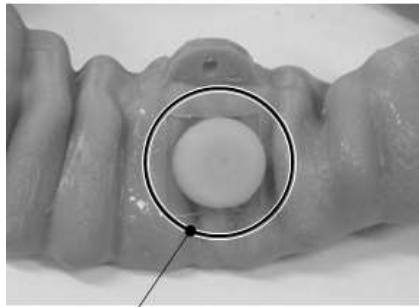

Remove inlet cap

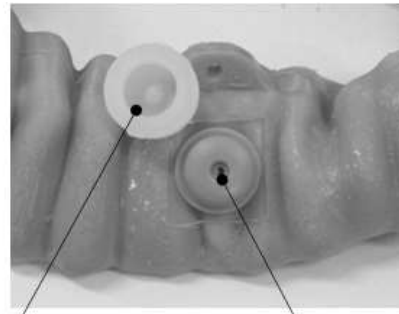

Removed cap

inlet

#### 4 – 5 Endoscope preparation

This model can simulate deformation caused by air insufflation and air suctioning by endoscope. Therefore, the following points should be noted.



Do not use water for the model. Please use a water bottle of an endoscope system without water.

## 5. Operation

### 5 – 1 Startup of the main unit

Press the power button. (The lamp on the button will light up blue.)

After a while, the following screen will appear on the monitor. (Screen during boot up)



The home screen is displayed.

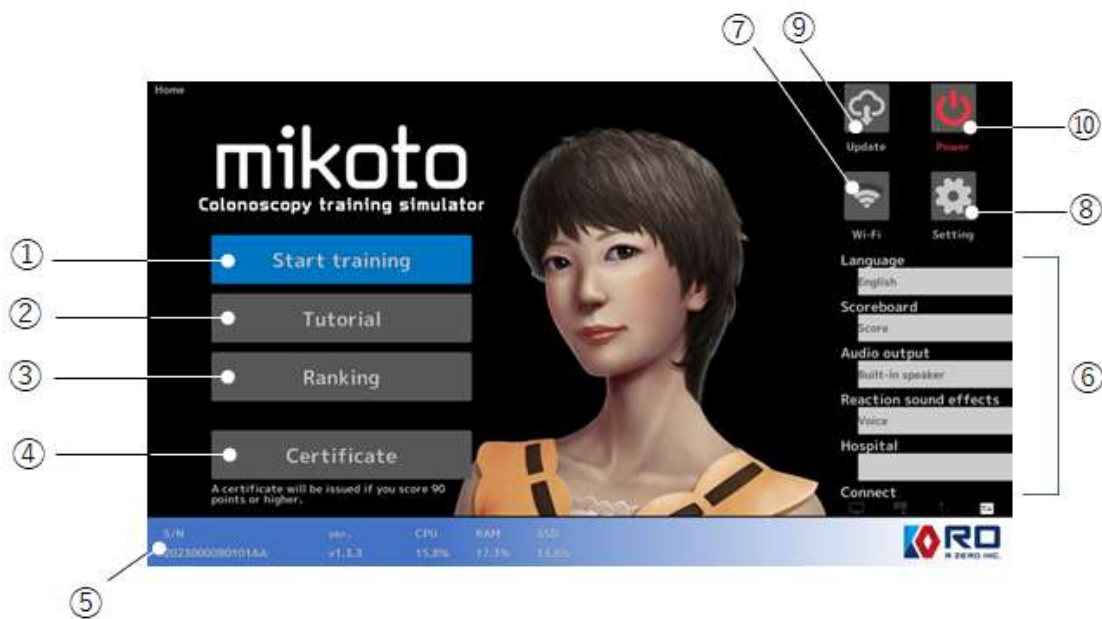

- ① : Move to training
- ② : Move to education videos
- ③ : Move to the result ranking
- ④ : Move to the certificate issuing screen
- ⑤ : Device information.
- ⑥ : The info of the selected language, scoreboard setting, audio output setting, sound setting and name of hospital. This is also the direct links of each function.

- ⑦ : The info of Wi-Fi connection
- ⑧ : Move to setting
- ⑨ : The info of updates
- ⑩ : Power off button

## 5 – 2 Start of training

When you select "Start Training," a screen for selecting the difficulty level will appear, so please select one of the options ① to ④.

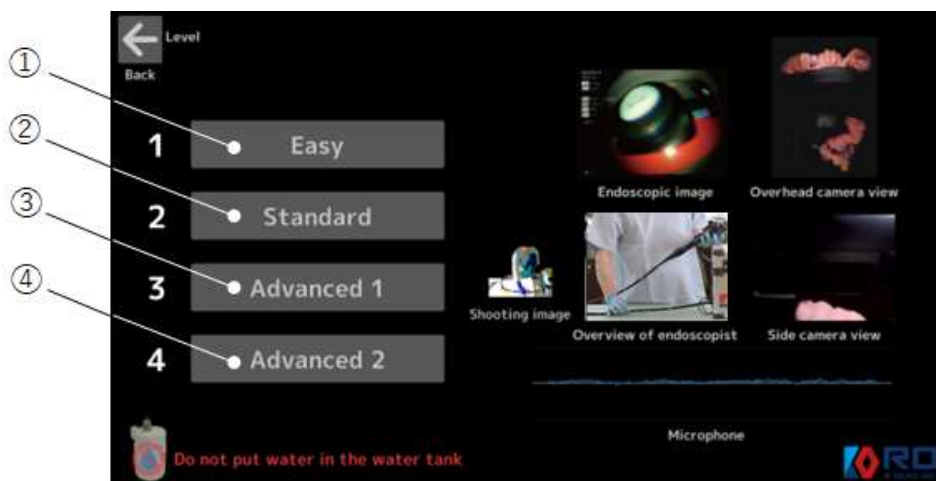

- ① : The abdominal pressure plate moves toward the anus.
- ② : Start with the default settings.
- ③ : The difficulty adjustment mechanism moves one step toward the anus.
- ④ : The difficulty adjustment mechanism moves to the anal side in two steps.

※Default setting: Abdominal compression plate is at the center of the abdominal cavity, and the difficulty adjustment mechanism is at the most center of the abdominal cavity.

※Don't fill the water bottle of endoscope system by water.

To set the colon model to the starting position, as illustrated on the screen, once the main unit is inverted to the left side supine position, it should be returned to its original position. The state is reflected on the screen. If you push "Start" button without following the instruction, the confirmation screen will be displayed.

After pushing "Start" button, a 7-second countdown will start. The beep sound starts from the rest 3 seconds. Please start training when it reaches 0 second.

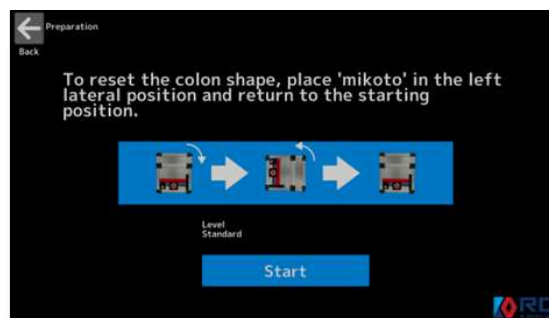
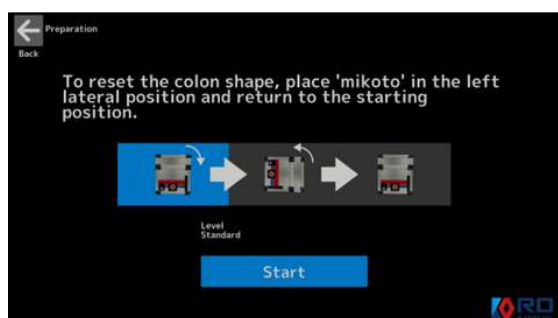



【Training start screen】

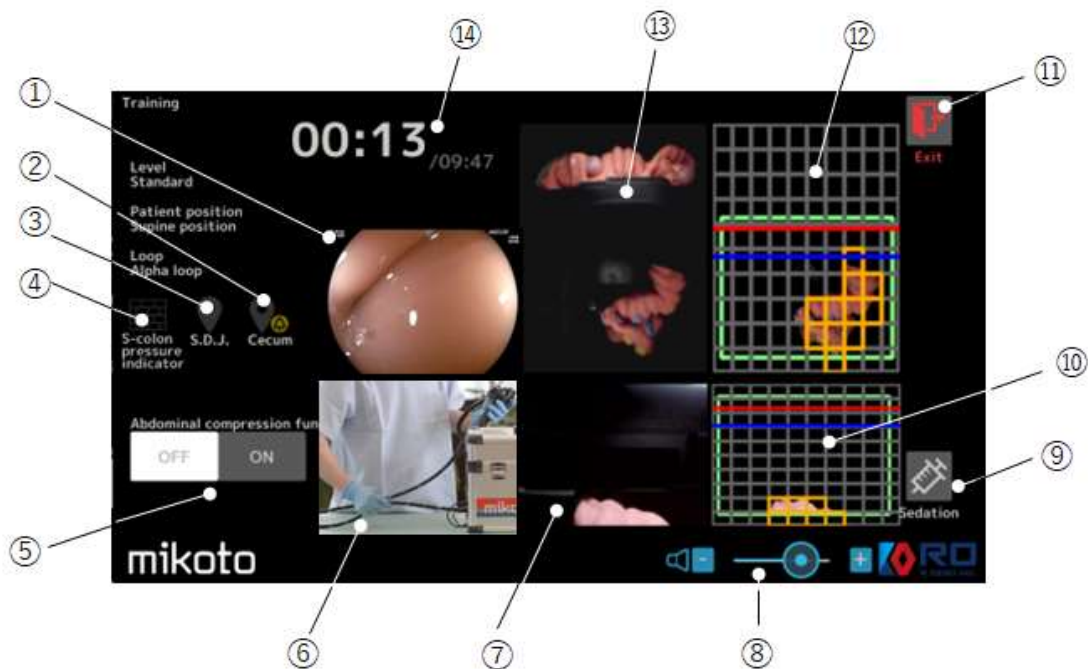

- ① Endoscopy image  
Captures and displays endoscope images.
- ② Cecum arrival button  
If the unit doesn't recognize the arrival to cecum automatically, please use this button to end the insertion training session.
- ③ Detection icon when passing SDJ  
When endoscope passes the SDJ, this icon is highlighted.
- ④ Sigmoid colon pressure sensor icon  
When the sigmoid colon pressure sensor detect a pressure, the icon is highlighted.

- ⑤ Abdominal compression support On/ Off button  
To make the endoscopic procedure easy, the abdominal compression support can be applied by using this button.
- ⑥ Operator's camera image  
Displays the video captured by the operator's camera. Please adjust the camera position so that the movement of your hands is displayed.
- ⑦ Side camera image  
Displays the internal image being captured by the side camera.
- ⑧ Sound volume
- ⑨ Sedative icon  
If selected, you can disable the human voice or beep that sounds when pain is detected.  
(1 minute/time) If it is selected again during the elapse of time, it will start again from that point.
- ⑩ Image analysis screen of side camera  
If the the colon model is elongated beyond the blue line, resulting a point deduction.  
If the colon model is elongated beyond the red line, a voice or a beep will be heard additionally.
- ⑪ Exit icon  
Training can be terminated even in the middle of a training session.
- ⑫ Image analysis screen of upper camera image  
If the the colon model is elongated beyond the blue line, resulting a point deduction.  
If the colon model is elongated beyond the red line, a voice or a beep will be heard additionally.
- ⑬ Upper camera image  
Displays the internal image being captured by the upper camera.
- ⑭ Training time display  
Each training session lasts 10 minutes. The time from the start of training and the remaining time are displayed.  
If operator can't reach cecum by 10 minutes, the training session end.

### 5 – 3 Observation

After reached to cecum, the observation training starts. Please start withdrawing and observe the mucosa and input the location and the number of detected lesions.

Your training result this time is... **86** /100

Observation time **05:12**

Skip

How many lesions did you have?

Part	Number of lesions
Ascending colon	1
Transverse colon	3
Descending colon	0
Sigmoid colon	1
Rectum	0
<b>Total</b>	<b>5</b>

Next

Illustration by *Kinamoto*

Elapsed time of observation

Pause button

Enter the number of lesions observed

### 5 – 4 Operator registration

When the observation evaluation is completed and the "Next" button is pushed, the following screen will appear.

To register the operator info, please select "Check your score". In the registration page, please input the operator's name and your experience.

\*If you select "Training" or "Home", the training video will be stored without these information.

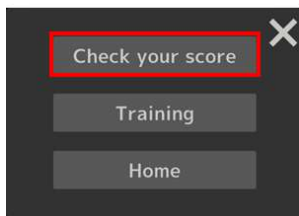

Operator

Name 0/30

Hospital 0/30

Experience

Trainee Trainer Other

Notes 0/30

Next

Name 0/30

mikoto

Back Next

	1	2	3	4	5	6	7	8	9	0	-	Details
	q	w	e	r	t	y	u	i	o	p	@	Back Space
Cap Lock	a	s	d	f	g	h	j	k	l	;	:	<
	z	x	c	v	b	n	m	.	?	_	>	
Alt	Space	!	#	\$	%	&	'	(	)	/	=	

Operator

Name 0/30

mikoto

Hospital 0/30

Experience

Trainee Trainer Other

Notes 0/30

Next



## 5 – 5 Replay of insertion training video

Once the name of the Operator who conducted the training is registered, the content of the training is automatically played back.

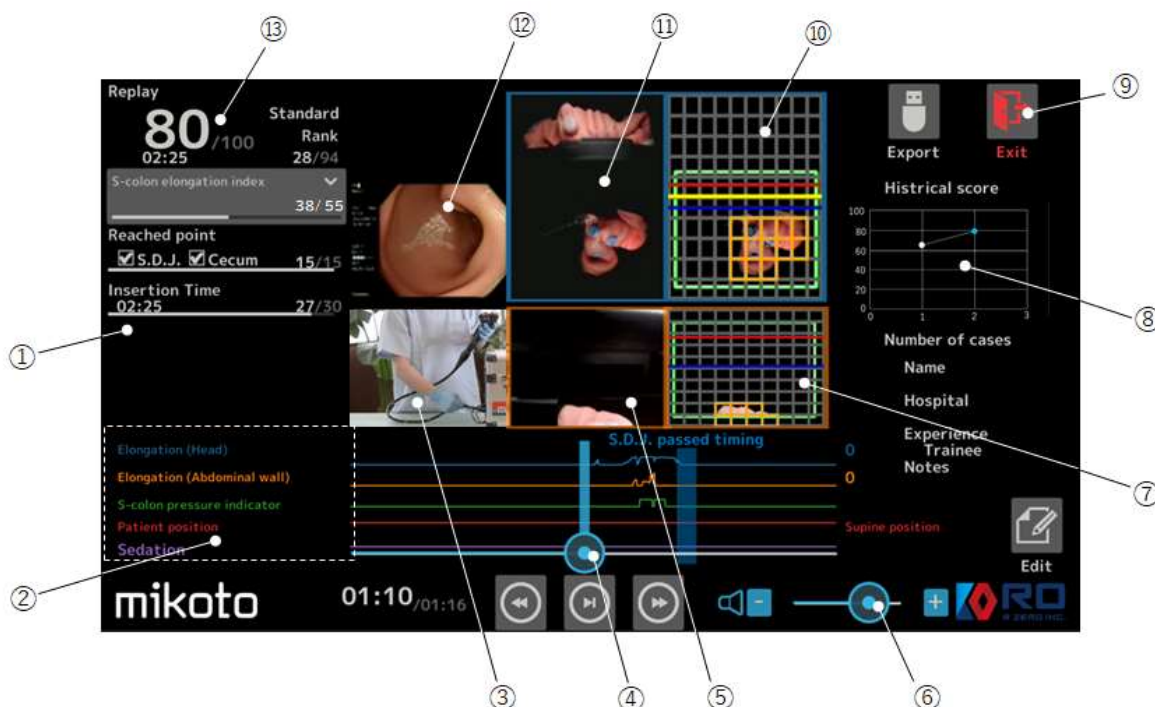

### ① Scoring results and observation evaluation

The scores of "Sigmoid-colon elongation index", "Abdominal compression\*", "S.D.J. reached", "Cecum reached", "Insertion Time", and score at each scoring point for "Insertion time".

\* Press "Show detail" button to find the details.

Elongation of the sigmoid colon by CMOS image recognition	
Before reaching S.D.J. at endoscope tip	3864
After reaching S.D.J. at endoscope tip	0
<b>Total</b>	<b>3864</b>
	33/45
S-colon pressure sensor active time	00:08
	5/10

①-1 : The index shown in ①-2 is calculated by monitoring the sigmoid colon elongation by the upper and side cameras. The higher the value of the index, the lower the score.

①-3 : The pressure sensor is on the abdominal compression plate. If endoscope pushed the sensor, the duration time was counted and is shown in ①-4. The longer time results lower score.



Enter the location of the lesion and the number of lesions identified and you can check the observation results.

※In the Observation time and observation rate indexes, you can also check the time taken to observe the lesion and the correct observation of the lesion as an observation rate.

You can also check the correctness of the observation results by selecting this index.

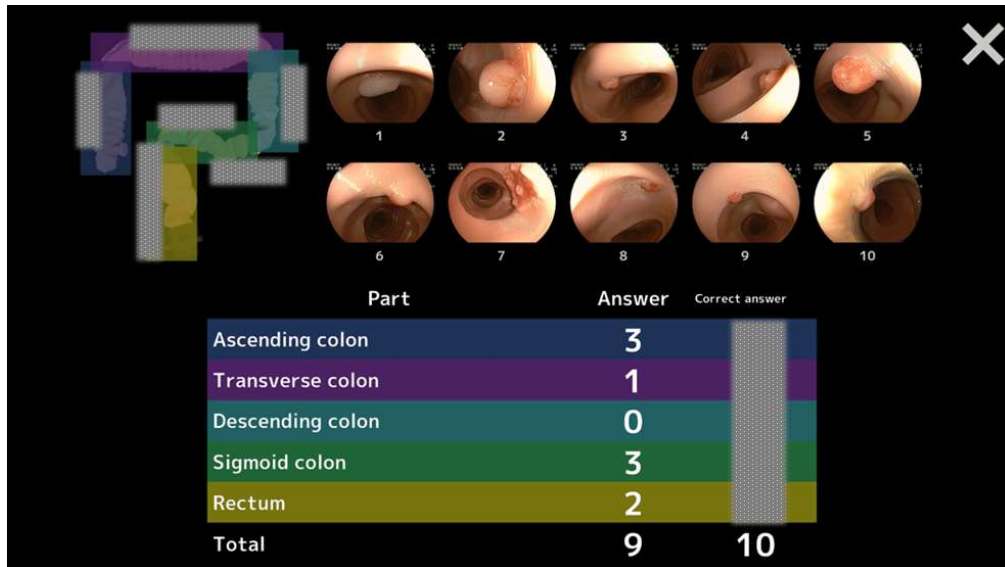

② Graph of each evaluation aspects

The graph shows the time trends of each evaluation aspects.

Elongation (Head)	Analyze the upper camera video and show the degree of the horizontal elongation.
Elongation (Abdominal wall)	Analyze the side camera video and show the degree of the perpendicular elongation.
S-colon pressure indicator	Show the timing that endoscope pressed the pressure sensor which is on the abdominal compression plate.
Posture position	Show the patient position.
Sedation	Show the timing and duration of the activated sedation function.

③ Operator's camera image

④ Replay Slide Bar

The play can be moved to any timing by dragging the slide bar.

⑤ Side camera image

⑥ Sound volume

- ⑦ Image analysis screen of side camera
- ⑧ Score history  
The score history of the operator is shown.
- ⑨ Exit icon  
It can be terminated even in the middle of replay.
- ⑩ Image analysis screen of upper camera image
- ⑪ Upper camera image
- ⑫ Endoscopy image
- ⑬ Score of insertion procedure

After selecting "Exit", "Training", "Ranking" and "Home" buttons are shown.

In the "Ranking", the list of all the recorded procedures and score history graph are shown. Each procedure can be replayed from the list.

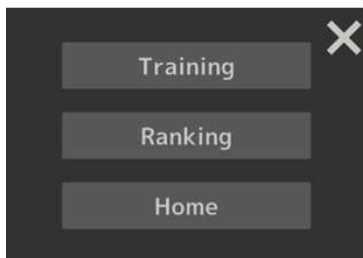
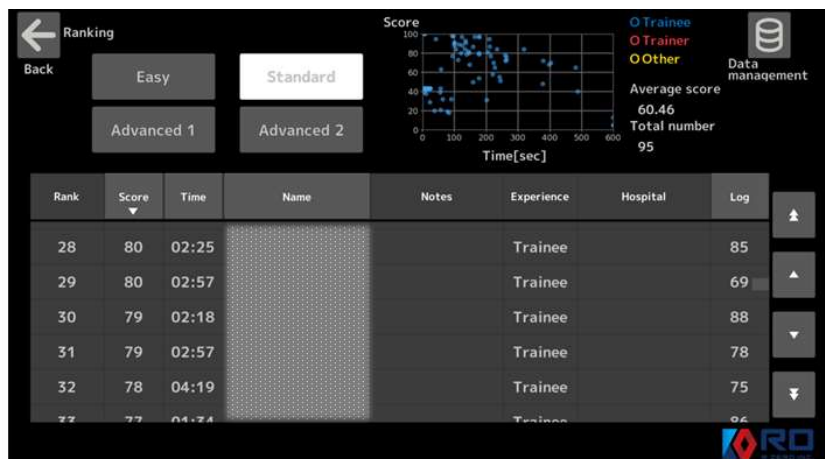



The 'Ranking' screen displays a scatter plot of Score (0-100) vs Time[sec] (0-600). The plot shows data points for Trainee (blue), Trainer (red), and Other (yellow). Summary statistics are shown: Average score 60.46, Total number 95. A table lists recorded procedures with columns for Rank, Score, Time, Name, Notes, Experience, Hospital, and Log. A 'Data management' icon is in the top right.

Rank	Score	Time	Name	Notes	Experience	Hospital	Log
28	80	02:25			Trainee		85
29	80	02:57			Trainee		69
30	79	02:18			Trainee		88
31	79	02:57			Trainee		78
32	78	04:19			Trainee		75
33	77	04:24			Trainee		96

## 5 – 6 Issue of certificates

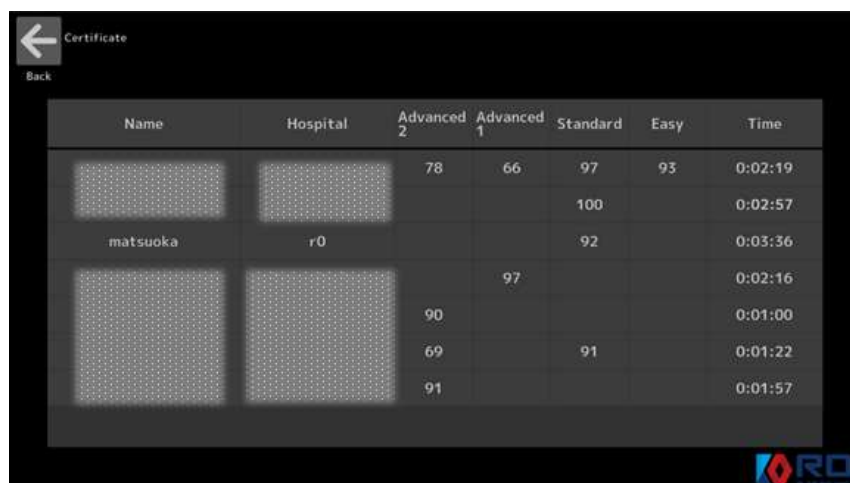
Select 'Certificates' on the home screen. Next, a list of the results of the practitioners who have scored 90 points or more in any of the difficulty levels in which they have trained will be displayed, so select the list for which you want to issue a certificate.

Name	Hospital	Advanced 2	Advanced 1	Standard	Easy	Time
[blurred]	[blurred]	78	66	97	93	0:02:19
[blurred]	[blurred]			100		0:02:57
matsuoka	r0			92		0:03:36
[blurred]	[blurred]		97			0:02:16
[blurred]	[blurred]	90				0:01:00
[blurred]	[blurred]	69		91		0:01:22
[blurred]	[blurred]	91				0:01:57

A QR code will appear, which you can scan with your smartphone to issue the certificate as PDF data.





Examples of certificates issue

## 5 – 7 Settings

Select "Settings" to view and change various settings.



### ① Wi-Fi

Displays Wi-Fi connection status. To make new connection, please select “Add new” and register it. Wi-Fi can also be switched off by unchecking the Wi-Fi box in the top left-hand corner.



※ When connecting for the first time, please check the contents of the agreement at (7) and only connect after agreeing to it.

② Language

The listed languages are available.

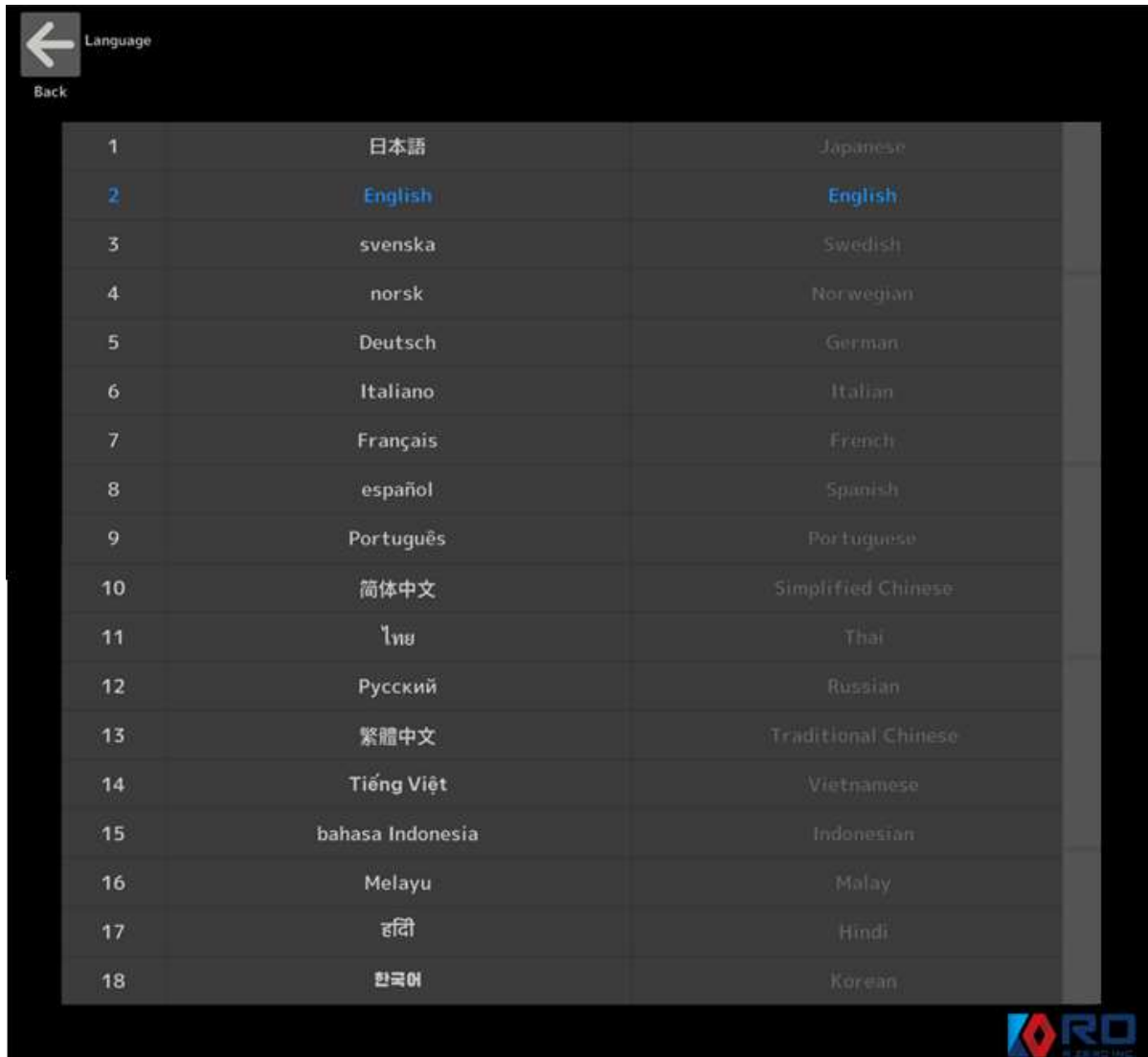

Number	Language (Native)	Language (English)
1	日本語	Japanese
2	English	English
3	svenska	Swedish
4	norsk	Norwegian
5	Deutsch	German
6	Italiano	Italian
7	Français	French
8	español	Spanish
9	Português	Portuguese
10	简体中文	Simplified Chinese
11	ไทย	Thai
12	Русский	Russian
13	繁體中文	Traditional Chinese
14	Tiếng Việt	Vietnamese
15	bahasa Indonesia	Indonesian
16	Melayu	Malay
17	हिंदी	Hindi
18	한국어	Korean

### ③ Display option

For home screen appearance, two options which are "Character" and "Device" are available.

For score board, two options are available. If you select "Score", it is displayed numerically. If you select "Grade", it is displayed alphabetically.

The training "Alert" function is for more detailed training. If it is activated, a yellow line appears in the image analysis screen of upper camera in insertion training. When the colon model is elongated beyond the yellow line, an audible "Pull back" will be output. The yellow line position can be changed by the slide bar beside.

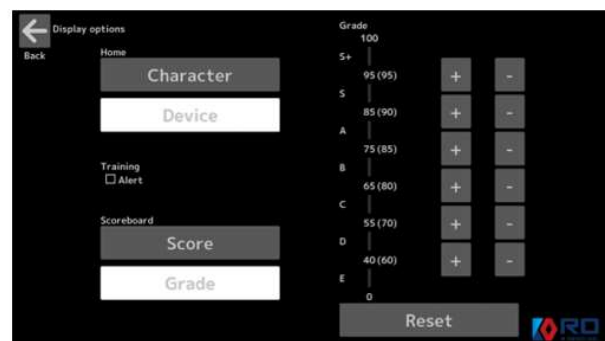
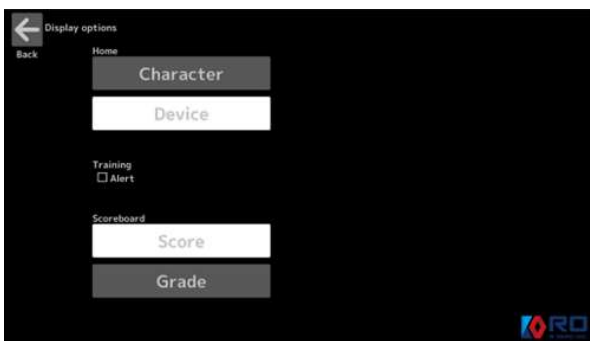

Character Display



Device Display

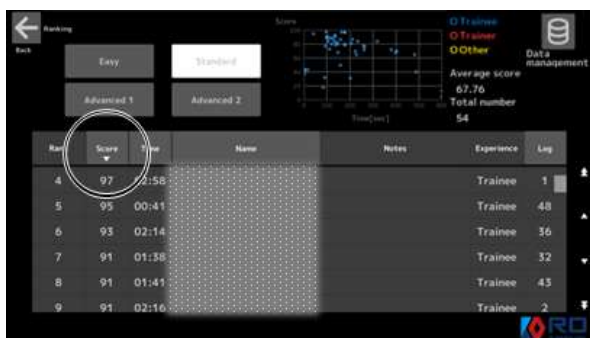

Score Display

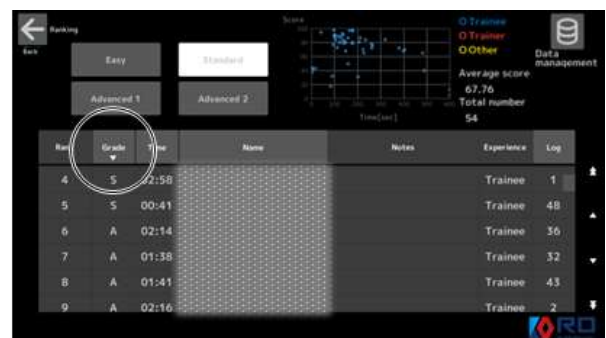

Grade Display

(※The operator's registered names are shown in the line "Name".)



The yellow sliding bar can be set between the blue line where the point reduction starts and the red line where the reaction sound is generated.



Display options screen

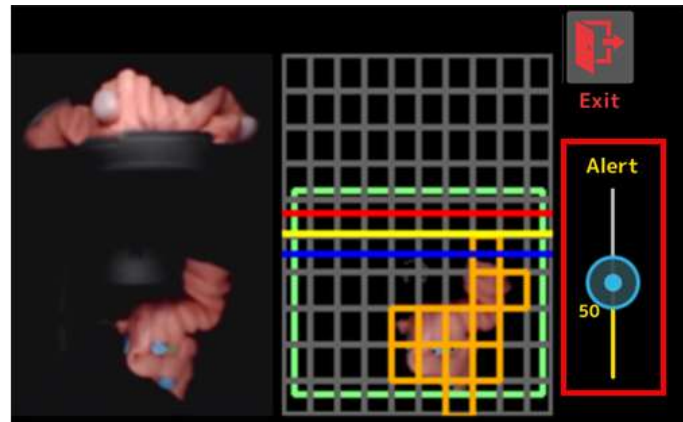

Training screen

#### ④ Sound option

The sensitivity of the microphone which is integrated to the operation camera can be changed by the slide bar. To reset it to the default setting, please push "Reset". The detected sound is visualized as a waveform.

"Reaction sound" can be selected from human voice or beep.

"Audio Output" can be selected from built-in speaker of main unit or an external speaker.





⑤ Sensor sensitivity

The sensitivity of the optical sensors to detect the endoscope location need to be changed depending on used endoscope system because the light power of endoscope depends on it. Please select your endoscope system.

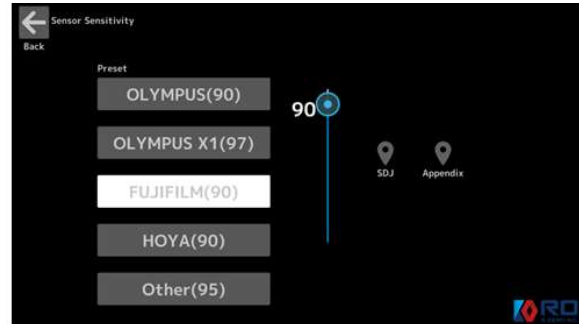
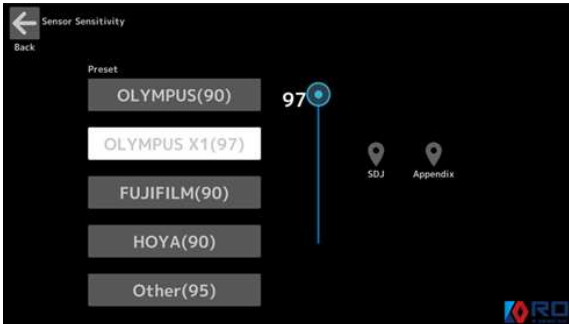

⑥ Register

Your region, country, facility name, and colon model replacement day can be registered as a memo.

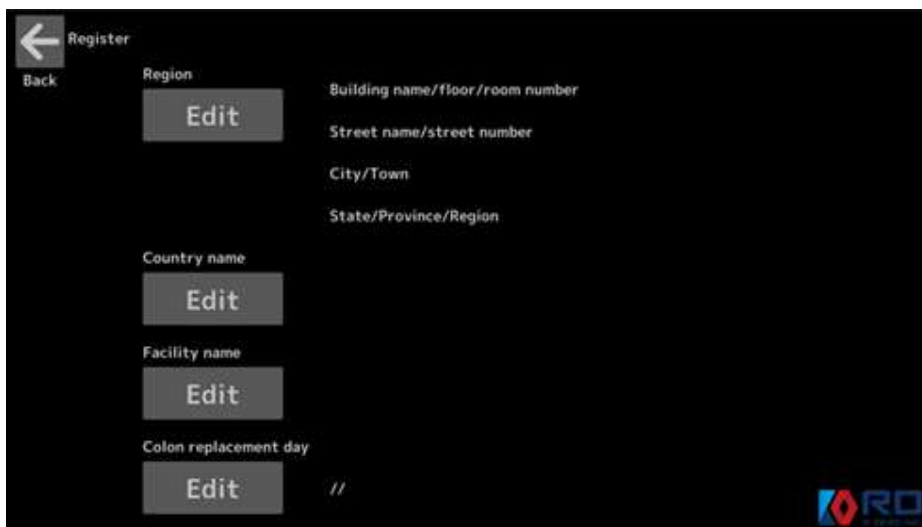

⑦ Consent form

Receiving update software and data transfer is handled as the following. If you agree with the terms and conditions, the Wi-Fi function will be available.

Users (hereinafter referred to as "User") of the next-generation medical simulator Mikoto Colonoscopy Model (hereinafter referred to as the "Simulator") hereby consent to the handling of transmitted and received data as defined in (1) below by RZERO Inc. (hereinafter referred to as the "Provider").

1. Data to be Transmitted and Received

- a) Transmitted Data: Data registered and recorded by the User as described in Table 1
- b) Received Data: Transmission data described in Table 1 provided by the Provider

2. Data Collection

The Provider may collect data regarding the User as indicated in Table 1 and may transmit this data to servers designated by the Provider. While this data may contain personal information, the User agrees that the collected data will be handled with appropriate measures for privacy and security.

3. Purpose of Data Collection

The User agrees that operational data is collected for purposes such as enhancing the functionality, customization, and analysis of the Simulator.

4. Data Sharing

The User agrees not to share operational data collected by the Provider with third parties, except for academic and research purposes with non-profit organizations. The User also acknowledges that data may be shared in accordance with legal requirements and regulations.

5. Costs Incurred during Transmission and Reception

The User agrees to bear the cost of network preparation, communication fees, and provider usage fees, among other network-related costs, when using the necessary network connection for transmission and reception.

6. System Updates, etc.

For the purpose of updates to the Simulator app, the Provider will provide the received data listed in Table 1 to the User through the User's prepared network. The User understands and agrees that in case of network issues, interruptions, errors, or other malfunctions, data loss may occur, and the User will not seek compensation from the Provider.

### 7. Withdrawal of Consent

The User has the right to withdraw consent for the transmission of operational data at any time. However, the User agrees that withdrawing consent may limit the receipt of medical examination data as indicated in Table 1, and the effect of withdrawal does not apply retroactively.

### 8. Governing Law

This consent form is governed by Japanese law.

Table 1 Contents of Transmitted and Received Data

Item	Contents
Transmission data	<ol style="list-style-type: none"> <li>1. User's registered name</li> <li>2. Registered name of the organization to which the user belongs</li> <li>3. Evaluation points</li> <li>4. Video of use</li> <li>5. Registered voice and address details</li> <li>6. Date, time and number of colon exchanges</li> <li>7. Operating time of actual machine</li> <li>8. Number of selections</li> <li>9. Device serial number</li> </ol>
Received data	<ol style="list-style-type: none"> <li>1. update data</li> <li>2. OS update data</li> </ol>

If you agree with the terms and conditions, check "I agree" and select "Next". Wi-Fi setting page appears. Please input SSID and the password.

If the unit is connected to the Wi-Fi, the message "Connection successful" will be displayed.

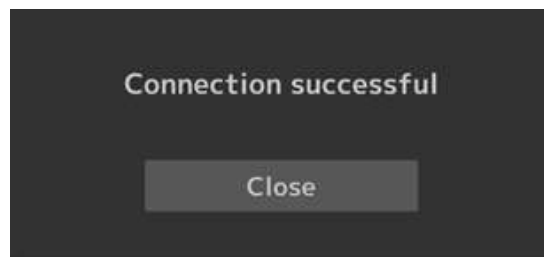
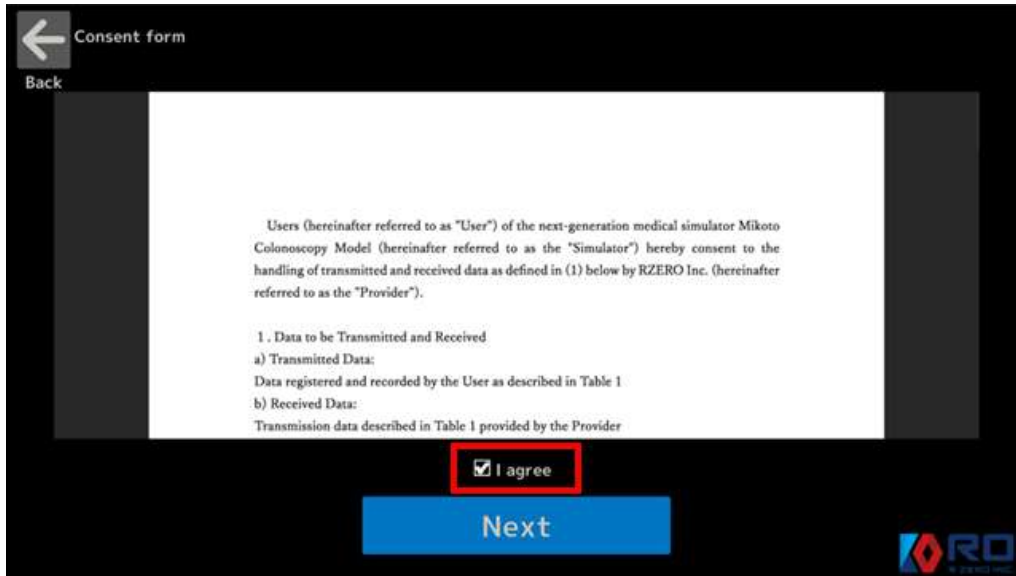

### ⑧ Data management

Displays a list of training information (difficulty, score, training time, etc.). Selected data can be exported to USB memory or deleted. When unplugging the USB, please do so after the message "Exported, please unplug the USB."

Please use a USB memory stick formatted in FAT32.

In the Data protection section, you can select 'Protect' and 'Do not protect' (default setting is 'Do not protect'), and in the Cloud section, you can select 'Enable' and 'Disable' (default setting is 'Enable') for data transmission when connected to Wi-Fi.



Log	Level	Score	Time	Name	Notes	Experience	Hospital	Protection	Cloud
161	Advanced 1	93	01:57			Trainee	No	Yes	
82	Advanced 1	93	02:07			Trainee	No	Yes	
180	Advanced 1	92	01:17			Trainee	No	Yes	
176	Advanced 1	91	01:25			Trainee	No	Yes	
169	Advanced 1	91	01:47			Trainee	No	Yes	
23	Advanced 1	87	02:31			Trainee	No	Yes	
109	Advanced 1	85	03:39			Trainee	No	Yes	

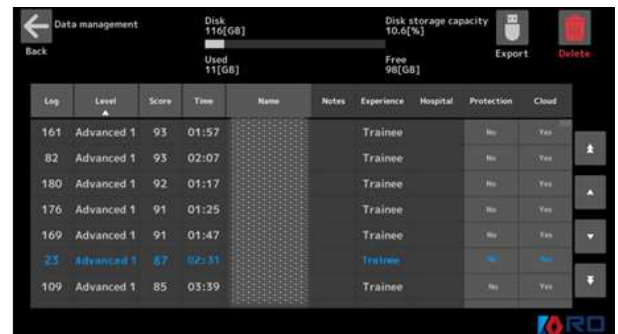

Log	Level	Score	Time	Name	Notes	Experience	Hospital	Protection	Cloud
161	Advanced 1	93	01:57			Trainee	No	Yes	
82	Advanced 1	93	02:07			Trainee	No	Yes	
180	Advanced 1	92	01:17			Trainee	No	Yes	
176	Advanced 1	91	01:25			Trainee	No	Yes	
169	Advanced 1	91	01:47			Trainee	No	Yes	
23	Advanced 1	87	02:31			Trainee	No	Yes	
109	Advanced 1	85	03:39			Trainee	No	Yes	

(The operator's registered names are shown in the line "Name".)

### ⑨ System log

The operating time of the unit, the number of trainings of each difficulty, the number of data exported to USB memory stick are shown.



Item	Value
Operating time	40:13:11
Easy	42
Standard	54
Advanced 1	15
Advanced 2	21
Export	3

⑩ License

Displays information of the licenses which is used by the unit.

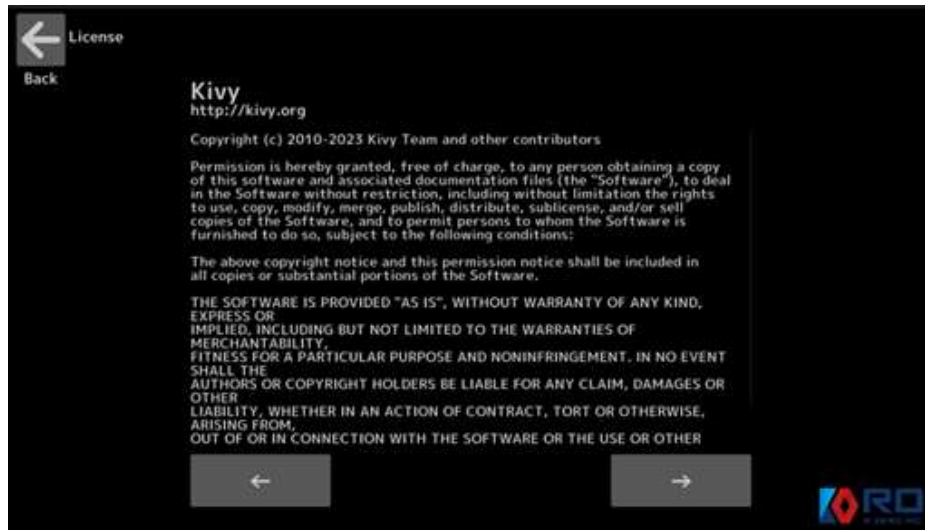

⑪ User's manual

The latest user's manual is available on web site.



## 5 – 8 Update

If the unit detected any software update while it is connected to WI-Fi, it will be shown in the figure below. For the update, please push "Update" button.

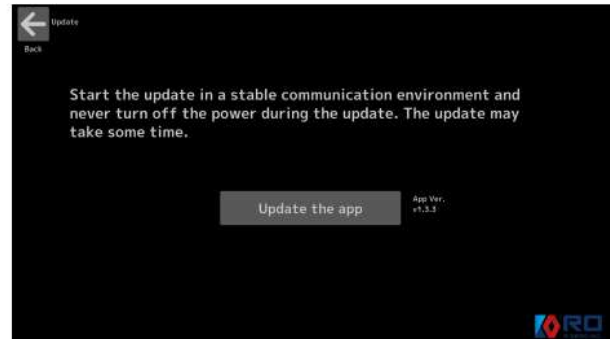

## 6. Exit operation

### 6 – 1 Power off

To shut down the main unit, press and hold the power button on the unit, or select the "Power" button in the home screen. The blue light on the power button on the unit will blink while the system is being shut down. After the blinking ends, unplug the power plug.

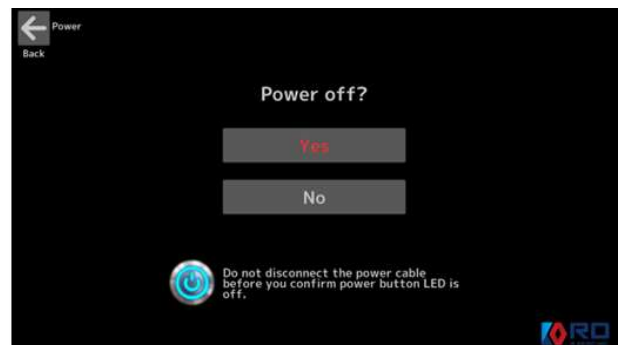

### 6 – 2 Installation of anal cap

To prevent leaking the lubricant, please insert the anal cap to the insertion port.

## 7. Specification

- Composition of lubricant: Refer to the safety data sheet.
- Lubricant form: Supplied by plastic bottle
- Usage of lithium battery: No
- Size and weight
  - Main unit : W417×D290×H327 mm (W:Including anal convexity, H: Including handle) , 8.7kg
  - Packing box : W470×D360×H470 mm, 12.6kg (Includes all components of the product)
- Power : Input : DC 12.0V 5.0A 60W
  - AC Adapter : AC 100V~240V 50~60Hz 1.5A MAX
- Basic internal PC software : Linux base
- Wireless LAN : IEEE802.11b, IEEE802.11g, IEEE802.11n, IEEE802.11ac
  - (2.4GHz band/5GHz band)
  - Frequency of operation : 2.4GHz(2412-2472MHz), 5GHz(5180-5700MHz)
  - Transmit power : 2.4GHz(+14.7dBm(max)), 5GHz(+14.0dBm(max))
- Environmental conditions : Indoor use, Altitude : Below 2,000m
  - Pollution degree of the intended environment : Pollution degree 2
- Operating temperature/humidity : 10~40°C/ 85%RH or less
- Storage temperature/humidity : -20~60°C/ 5~95% (There should be no condensation.)

## 8. Declaration of conformity

<b>【BG】</b> Bulgarian	С настоящото R ZERO Inc. декларира, че този тип радиосъоръжение R0CT01 е в съответствие с Директива 2014/53/ЕС. Цялостният текст на ЕС декларацията за съответствие може да се намери на следния интернет адреси QR код.
<b>【CS】</b> Czech	Tímto Společnost R ZERO Inc. prohlašuje, že typ rádiového zařízení R0CT01 je v souladu se směrnicí 2014/53/EU. Úplné znění EU prohlášení o shodě je k dispozici na této internetové adrese a QR kód.
<b>【DA】</b> Danish	Hermed erklærer R ZERO Inc., at radioudstyrstypen R0CT01 er i overensstemmelse med direktiv 2014/53/EU. EU-overensstemmelseserklæringens fulde tekst kan findes på følgende Internetadresse og QR-kode.
<b>【DE】</b> German	Hiermit erklärt R ZERO Inc., dass die Funkanlage des Typs "R0CT01" mit der Richtlinie 2014/53/EU konform ist. Der vollständige Text der EU-Konformitätserklärung ist unter der folgenden Internetadresse und dem QR-Code verfügbar.









<b>【EL】</b> Greek	Με την παρούσα ο/η H R ZERO Inc., δηλώνει ότι ο ραδιοεξοπλισμός R0CT01 πληροί την οδηγία 2014/53/EE. Το πλήρες κείμενο της δήλωσης συμμόρφωσης EE διατίθεται στην ακόλουθη ιστοσελίδα στο διαδίκτυο και κωδικό QR.
<b>【EN】</b> English	Hereby, R ZERO Inc. declares that the radio equipment type "R0CT01" is in compliance with Directive 2014/53/EU. The full text of the EU declaration of conformity is available at the following internet address and QR code.
<b>【ES】</b> Spanish	Por la presente, R ZERO Inc., declara que el tipo de equipo radioeléctrico "R0CT01" es conforme con la Directiva 2014/53/UE. El texto completo de la declaración UE de conformidad está disponible en la dirección Internet siguiente y código QR.
<b>【ET】</b> Estonian	Käesolevaga deklareerib R ZERO Inc., et käesolev raadioseadme tüüp R0CT01 vastab direktiivi 2014/53/EL nõuetele. ELi vastavusdeklaratsiooni täielik tekst on kättesaadav järgmisel internetiaadressil ja QR-kood.
<b>【FI】</b> Finnish	R ZERO Oy vakuuttaa, että radiolaitetyyppi R0CT01 on direktiivin 2014/53/EU mukainen. EU-vaatimustenmukaisuusvakuutuksen täysimittainen teksti on saatavilla seuraavassa internetosoitteessa ja QR-koodi.
<b>【FR】</b> French	Par la présente, R ZERO Inc. déclare que l'équipement radio de type "R0CT01" est conforme à la directive 2014/53/EU. Le texte complet de la déclaration UE de conformité est disponible à l'adresse internet suivante et code QR.
<b>【GA】</b> Irish	Dá bhrí sin, dearbhaíonn R ZERO Inc. go bhfuil an cineál trealaimh raidió "R0CT01" i gcomhréir le Treoir 2014/53/AE. Tá téacs iomlán an dearbhaithe comhréireachta AE ar fáil ag an seoladh idirlín seo a leanas agus QR.
<b>【HR】</b> Croatian	Ovime R ZERO Inc. izjavljuje da je tip radio opreme "R0CT01" u skladu s Direktivom 2014/53/EU. Cjeloviti tekst EU izjave o sukladnosti dostupan je na sljedećoj internetskoj adresi i QR kod.
<b>【HU】</b> Hungarian	Az R ZERO Inc. igazolja, hogy a R0CT01 típusú rádióberendezés megfelel a 2014/53/EU irányelvnek. Az EU-megfelelőségi nyilatkozat teljes szövege elérhető a következő internetes címen és QR-kód.
<b>【IT】</b> Italian	Il fabbricante, R ZERO Inc., dichiara che il tipo di apparecchiatura radio "R0CT01" è conforme alla direttiva 2014/53/UE. Il testo completo della dichiarazione di conformità UE è disponibile al seguente indirizzo Internet e codice QR.
<b>【LT】</b> Lithuanian	Aš, R ZERO Inc., patvirtinu, kad radijo įrenginių tipas R0CT01 atitinka Direktyvą 2014/53/ES. Visas ES atitikties deklaracijos tekstas prieinamas šiuo interneto adresu ir QR kodas.
<b>【LV】</b> Latvian	Ar šo R ZERO Inc. deklarē, ka radioiekārta R0CT01 atbilst Direktīvai 2014/53/ES. Pilns ES atbilstības deklarācijas teksts ir pieejams šādā interneta vietnē un QR kods.







<b>【NL】</b> Dutch	Hierbij verklaar ik, R ZERO Inc., dat het type radioapparatuur “R0CT01” conform is met Richtlijn 2014/53/EU. De volledige tekst van de EU-conformiteitsverklaring kan worden geraadpleegd op het volgende internetadres en QR-code.
<b>【PL】</b> Polish	R ZERO Inc. niniejszym oświadcza, że typ urządzenia radiowego R0CT01 jest zgodny z dyrektywą 2014/53/UE. Pełny tekst deklaracji zgodności UE jest dostępny pod następującym adresem internetowym i kod QR.
<b>【PT】</b> Portuguese	O(a) abaixo assinado(a) R ZERO Inc. declara que o presente tipo de equipamento de rádio R0CT01 está em conformidade com a Diretiva 2014/53/UE. O texto integral da declaração de conformidade está disponível no seguinte endereço de Internet e código QR.
<b>【RO】</b> Romanian	Prin prezenta, R ZERO Inc. declară că tipul de echipamente radio R0CT01 este în conformitate cu Directiva 2014/53/UE. Textul integral al declarației UE de conformitate este disponibil la următoarea adresă internet și codul QR.
<b>【SK】</b> Slovak	Spoločnosť R ZERO Inc. týmto vyhlasuje, že rádiové zariadenie typu R0CT01 je v súlade so smernicou 2014/53/EÚ. Úplné EÚ vyhlásenie o zhode je k dispozícii na tejto internetovej adrese a QR kód.
<b>【SL】</b> Slovenian	R ZERO Inc. potrjuje, da je tip radijske opreme R0CT01 skladen z Direktivo 2014/53/EU. Celotno besedilo izjave EU o skladnosti je na voljo na naslednjem spletnem naslovu in QR kodo.
<b>【SV】</b> Swedish	Härmed försäkrar R ZERO Inc. att denna typ av radioutrustning R0CT01 överensstämmer med direktiv 2014/53/EU. Den fullständiga texten till EU-försäkran om överensstämmelse finns på följande webbadress och QR-kod.

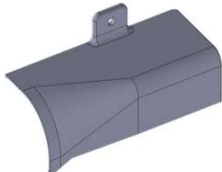

URL : <https://rzero.jp/mikoto/doc.html>

## 9. Optional parts (consumables)

No	Name	Type	Quantity	Product
1	Colon model (※)	R0DS	1	
2	Lubricant (※)	R0CMT	50ml×2	
3	Colon model's Transverse colon hook attachment spring	R0DS-S1	1	
4	Colon model's Sigmoid colon rubber spring	R0DS-S2	1	
5	Colon model's Anal area lubrication panel	R0DS-CP	1	
6	Colon model's anal cap	RSDS-CAP	1	

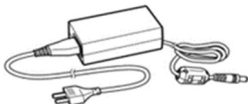
No	Name	Type	Quantity	Product
7	Colon model's SDJ section resin cover	R0DS-SDJRC	1	
8	Colon model's Ascending colon section resin cover	R0DS-ACRC	1	
9	Colon model's caecum section resin cover	R0DS-CRC	1	
10	Screws for resin cover	R0DS-RSC	5	
11	Screws for lubrication panels	R0DS-LSC	4	
12	Operator's camera	GP-CAM2FM	1	
13	USB analog video capture	R0-USBVC	1	
14	AC adapter	6A-601DB12	1	

※ : These parts are not included in the parts covered under the free of charge warranty period. Other parts are also not covered if the damage or loss is intentional or negligent - please note that the warranty does not cover these parts.

## Inquiries

R ZERO Inc.  
 2-218, kamo-cho, Yonago-shi, Tottori, 683-0823, JAPAN  
 mikoto@rzero.jp